



Washer, Electrical Equipment Bond

WEEB[®] WASHER

INSTALLATION INSTRUCTIONS

For PMC Solar Galvanized Purlin Mounting System only

Burndy LLC recommends that the sufficient details of the installation be submitted to the AHJ for approval before any work is started.

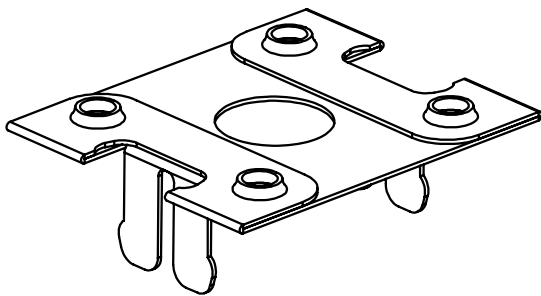

WEEB-DMC

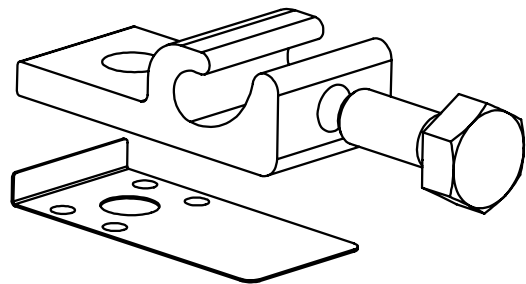

WEEB-LUG-6.7



Products are tested to UL 467, CAN/CSA-C22.2 No. 41
US/ Canadian standards for safety grounding and bonding equipment.



WEEB[®] WASHER COMPATIBILITY

The WEEB[®] washer family of products can be used to bond anodized aluminum, galvanized steel, steel and other electrically conductive metal structures. All installations shall be in accordance with NEC requirements in the USA and with CSA C22.1 in Canada. The WEEB[®] washers are for use with modules that have a maximum fuse rating of less than 25A.

Certain module frames do not have enough structural strength to withstand the force required to embed a WEEB[®] washer. These frames will deform and therefore not allow sufficient penetration of the WEEB[®] washer teeth. The general requirements for minimum module frame thickness of "boxed" type module frames are illustrated below. For more information regarding module compatibility, please see the technical documents section of our website.

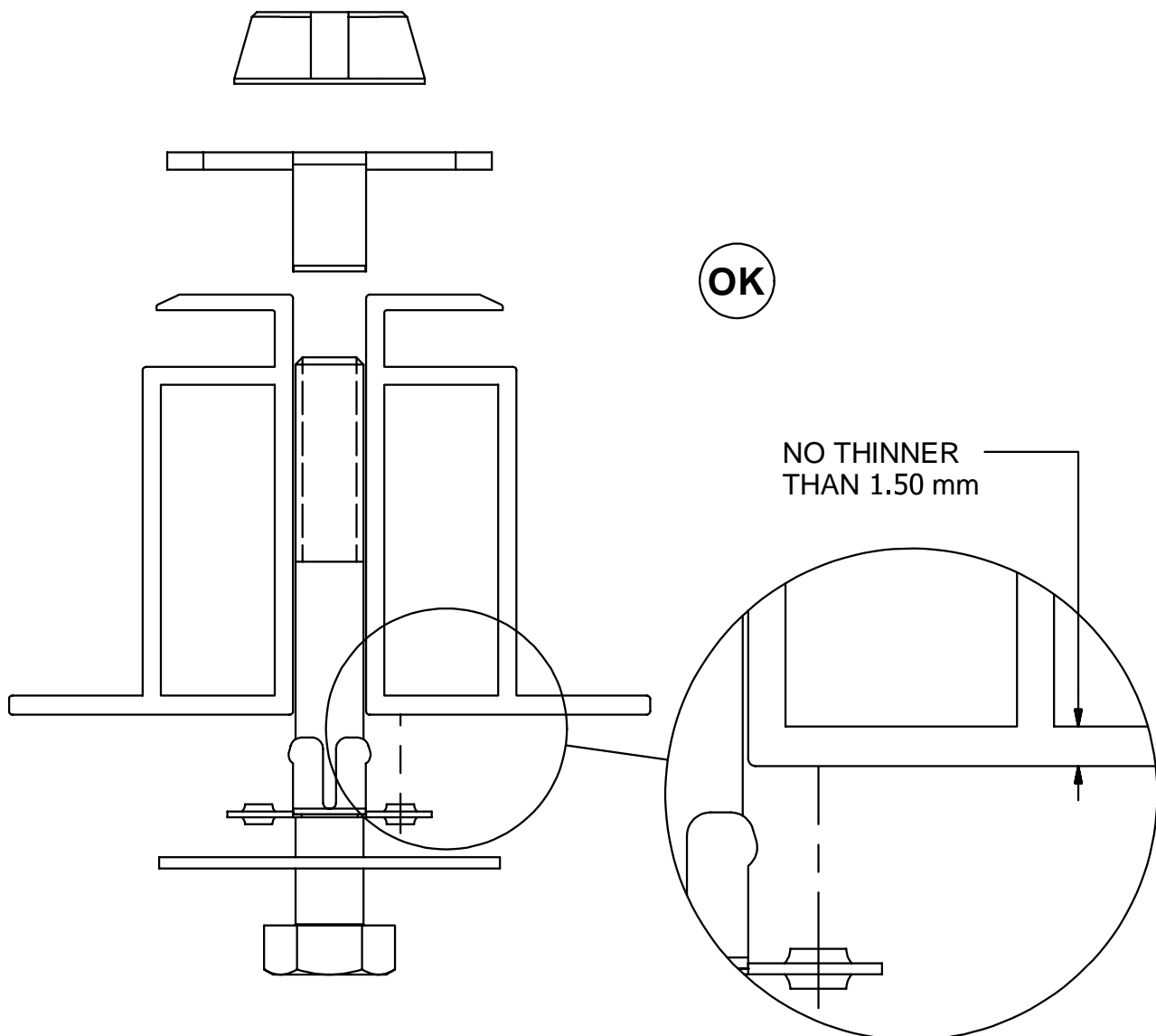

Note:

Inspect each module frame used with a WEEB[®] device to ensure that the bottom mounting face of the frame is flat, and that there are no hindrances to embedding WEEB[®] washer teeth. Do not use a module with a frame that prevents the WEEB[®] washer teeth from embedding fully.

SYSTEM OVERVIEW

Drill bolt clearance hole \varnothing 17/64in [7mm] on center of purlin. Assemble WEEB-LUG-6.7 assembly and torque fasteners to 10 ft-lb / 13.5 N-m using Penetrox-A on threads.

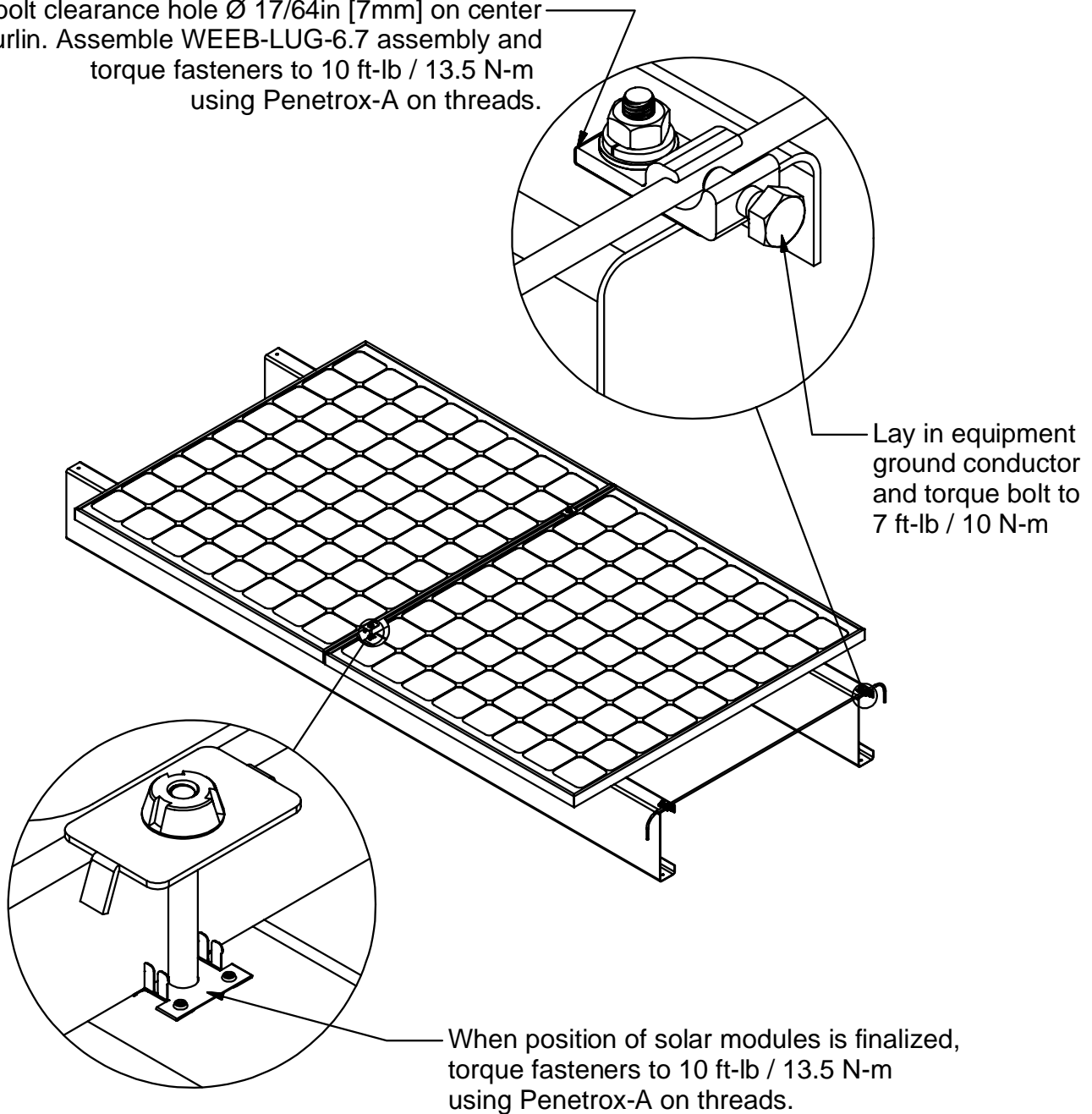

Important notes:

1. These installation instructions are identical for both landscape and portrait oriented PV modules. Refer to module's installation instructions for clamping recommendations.
2. Use general purpose anti-seize compound on fastener threads when installing WEEB® washers.
3. The NEC section 690.43 states "Exposed non-current carrying metal parts of module frames, equipment, and conductor enclosures shall be grounded in accordance with 250.134 or 250.136(A) regardless of voltage".

WEEB-DMC LAYOUT PORTRAIT MODULE ORIENTATION

EVEN NUMBER OF MODULES IN ROW

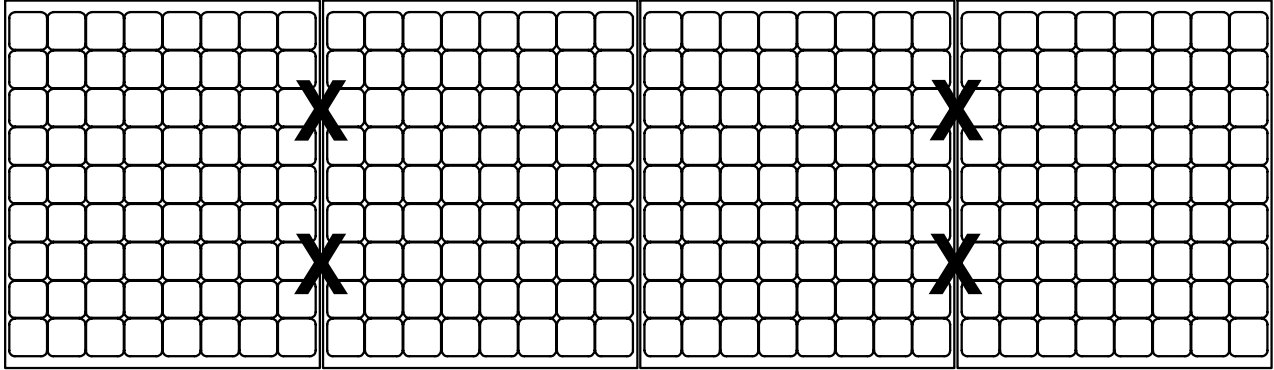

X DENOTES PLACES TO INSTALL WEEB-DMC

COLUMN X ROW = C X R = 4 X 1 = 4

WEEB-DMC NEEDED = 4

ODD NUMBER OF MODULES IN ROW

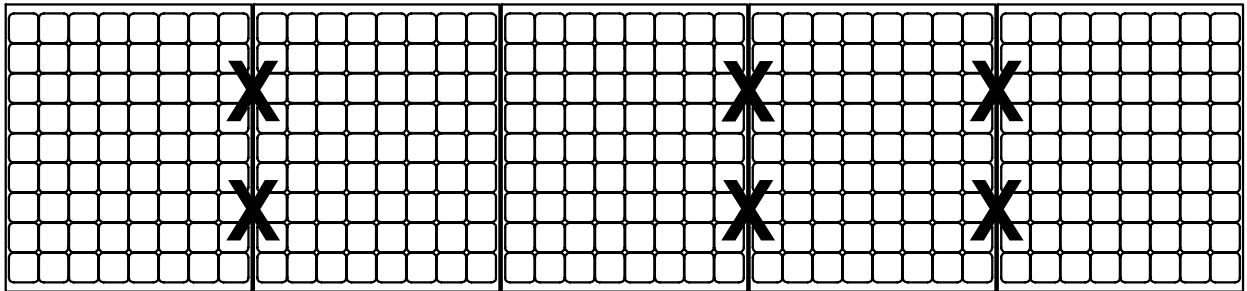

X DENOTES PLACES TO INSTALL WEEB-DMC

[COLUMN + 1] X ROW = [C + 1] X R = [5 + 1] X 1 = 6

WEEB-DMC NEEDED = 6

Note:

When replacing a single faulty module, also remove the adjacent module which contacts the same WEEB® washers as the faulty module. This will ensure that there are never ungrounded modules in the array.

WEEB-LUG-6.7 LOCATIONS

Install WEEB-LUG-6.7's at the following marked locations. Lug position is the same in both portrait and landscape configurations.

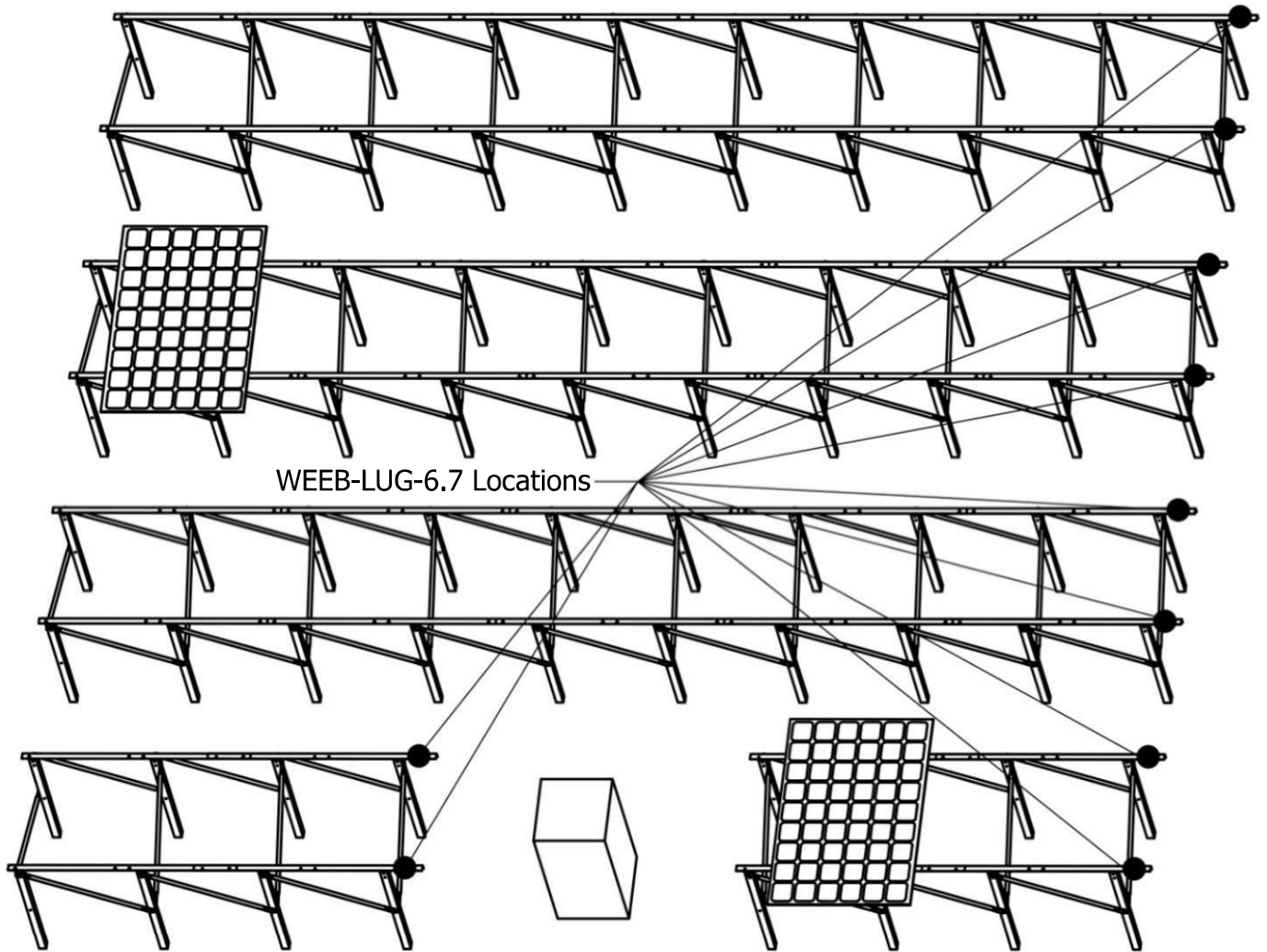

Customer Service Department
7 Aviation Park Drive
Londonderry, NH 03053
1-800-346-4175
1-603-647-5299 (International)