



Washer, Electrical Equipment Bond

WEEB[®] WASHER

INSTALLATION INSTRUCTIONS *For SunEdison AP90-1.5 Tracker System only*

Burndy LLC recommends that the sufficient details of the installation be submitted to the AHJ for approval before any work is started.

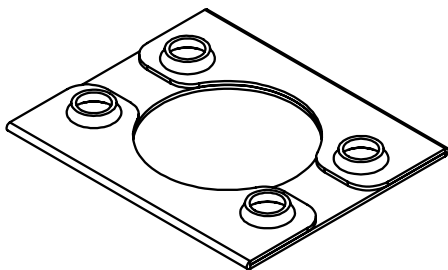

WEEB-9.5NL

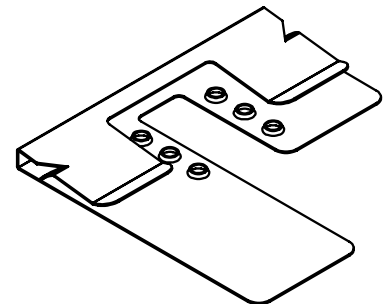

WEEB-FBM516

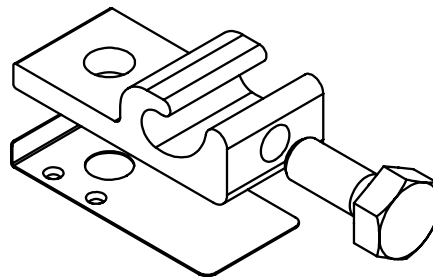

WEEB-LUG-6.7



Products are tested to UL 467, CAN/CSA-C22.2 No. 41
US/ Canadian standards for safety grounding and bonding equipment.



WEEB-9.5NL COMPATIBILITY

The WEEB® washer family of products can be used to bond anodized aluminum, galvanized steel, steel and other electrically conductive metal structures. All installations shall be in accordance with NEC requirements in the USA and with CSA C22.1 in Canada. The WEEB® washers are for use with modules that have a maximum fuse rating of less than 25A.

Certain module frames do not have enough structural strength to withstand the force required to embed a WEEB® washer. These frames will deform and therefore not allow sufficient penetration of the WEEB® washer teeth. The general requirements for minimum module frame thickness of "boxed" type module frames are illustrated below. For more information regarding module compatibility, please see the technical documents section of our website.

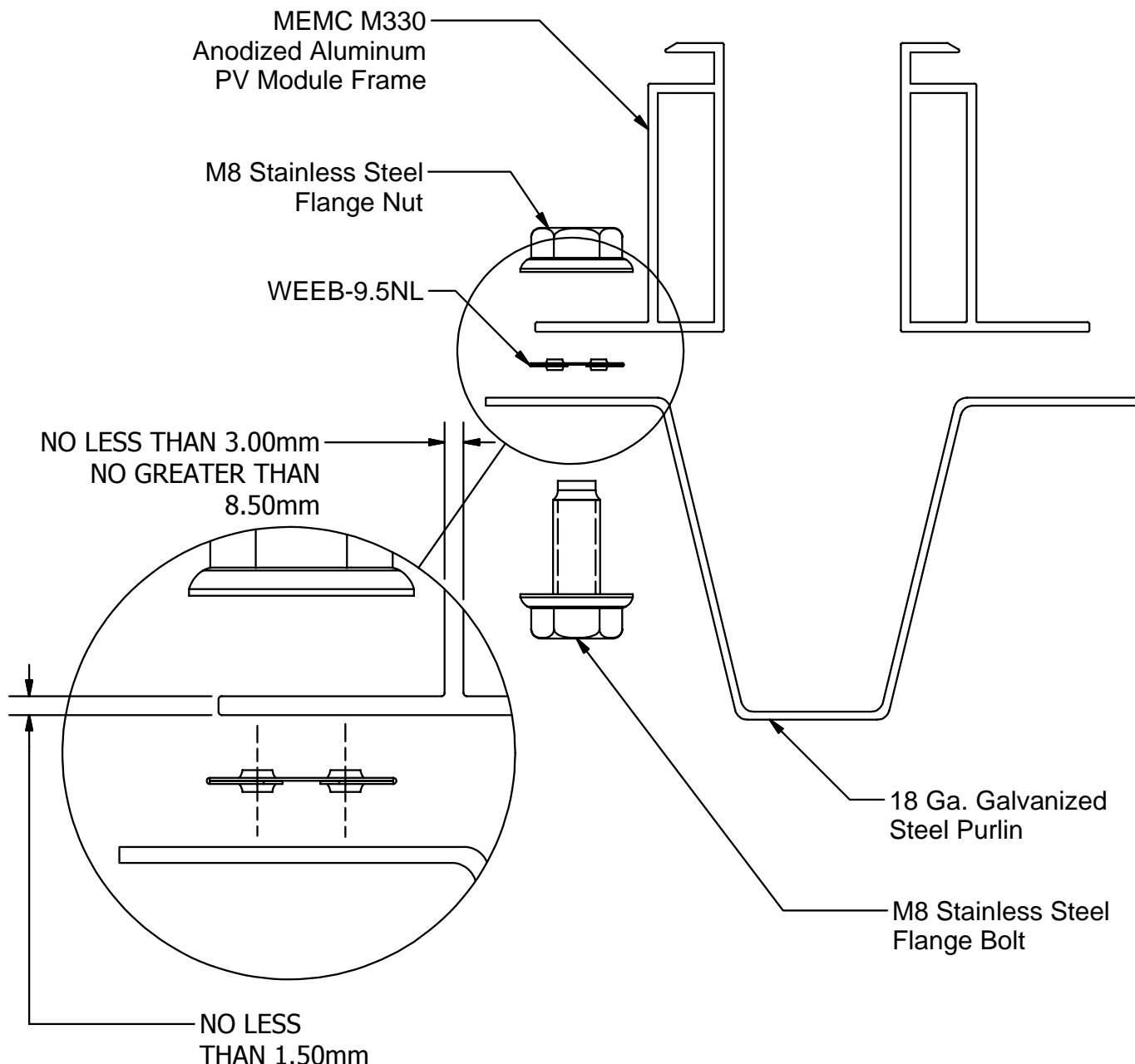

Note:

Inspect each module frame used with a WEEB® device to ensure that the bottom mounting face of the frame is flat, and that there are no hindrances to embedding WEEB® washer teeth. Do not use a module with a frame that prevents the WEEB® washer teeth from embedding fully.

SYSTEM OVERVIEW USING WEEB-9.5NL

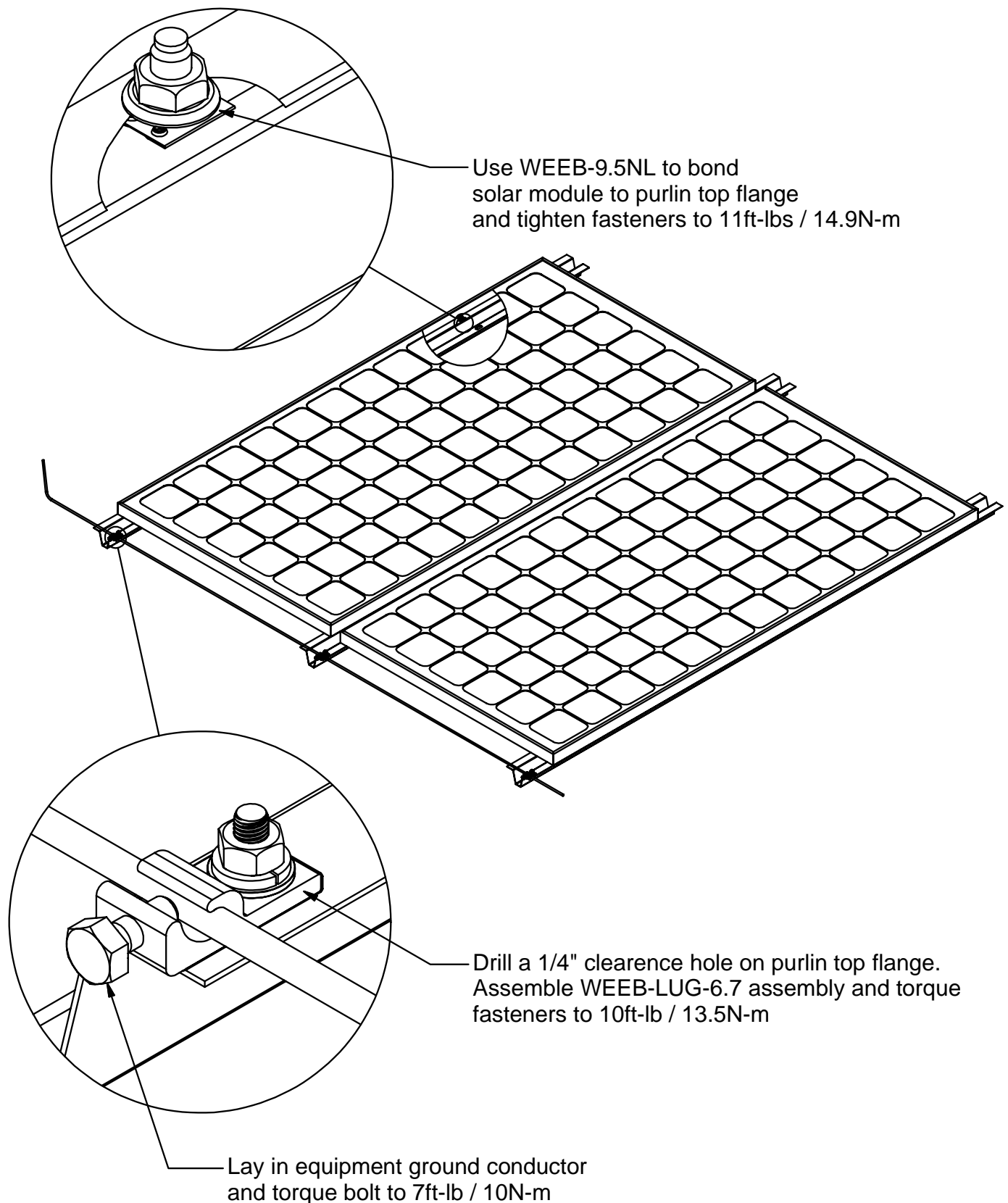

Important notes:

1. The NEC section 690.43 states "Exposed non-current carrying metal parts of module frames, equipment, and conductor enclosures shall be grounded in accordance with 250.134 or 250.136(A) regardless of voltage".

WEEB-9.5NL LAYOUT

EVEN NUMBER OF MODULES IN ROW

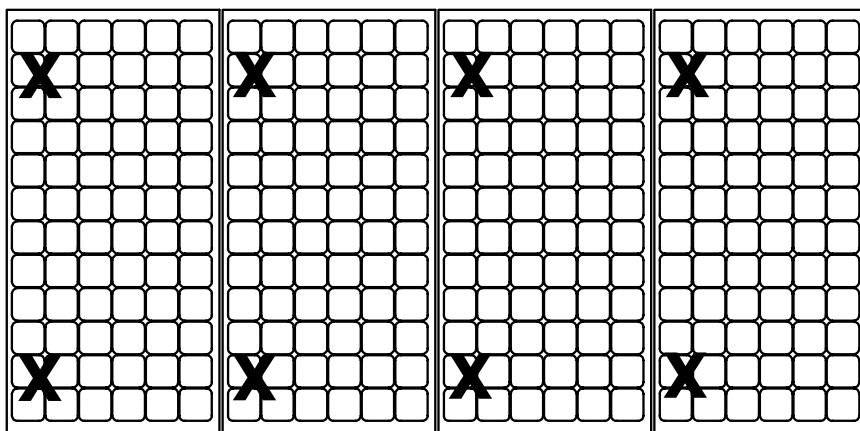

X DENOTES PLACES TO INSTALL WEEB-9.5NL

$$C \times R = 4 \times 1$$

$$\text{WEEB-9.5NL NEEDED} = 2 \times C \times R = 2 \times 4 \times 1 = 8$$

ODD NUMBER OF MODULES IN ROW

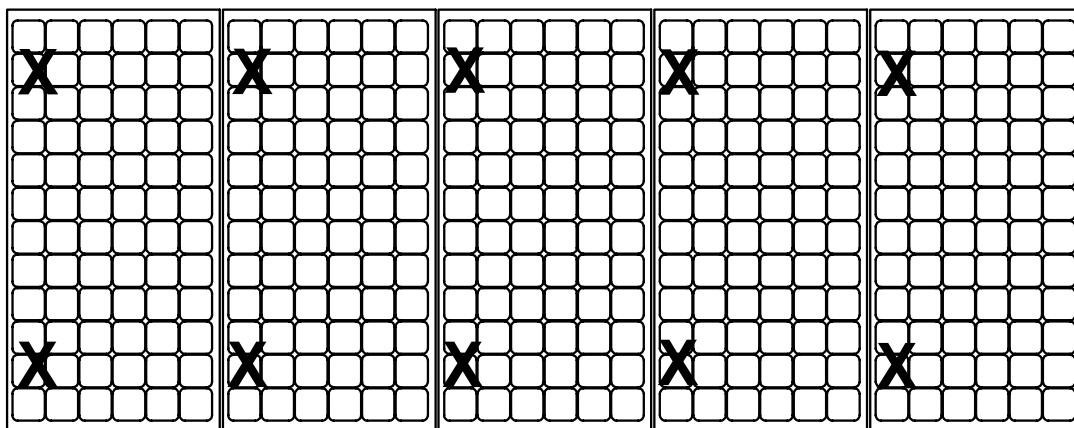

X DENOTES PLACES TO INSTALL WEEB-9.5NL

$$C \times R = 5 \times 1$$

$$\text{WEEB-9.5NL NEEDED} = 2 \times C \times R = 2 \times 5 \times 1 = 10$$

WEEB-FBM516 COMPATIBILITY

The WEEB® washer family of products can be used to bond anodized aluminum, galvanized steel, steel and other electrically conductive metal structures. All installations shall be in accordance with NEC requirements in the USA and with CSA C22.1 in Canada. The WEEB® washers are for use with modules that have a maximum fuse rating of less than 25A.

Certain module frames do not have enough structural strength to withstand the force required to embed a WEEB® washer. These frames will deform and therefore not allow sufficient penetration of the WEEB® washer teeth. The general requirements for minimum module frame thickness of "boxed" type module frames are illustrated below. For more information regarding module compatibility, please see the technical documents section of our website.

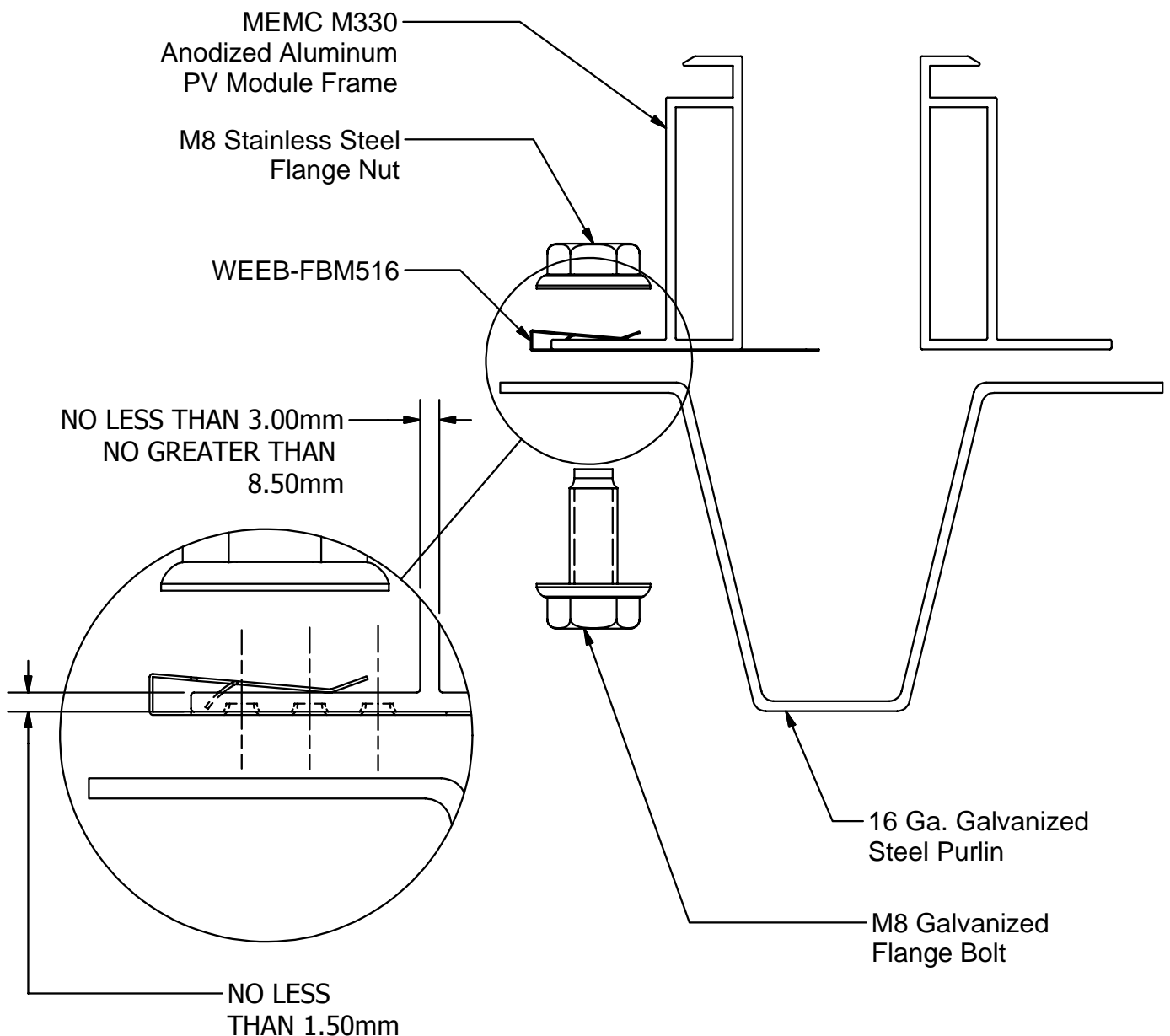

Note:

Inspect each module frame used with a WEEB® device to ensure that the bottom mounting face of the frame is flat, and that there are no hindrances to embedding WEEB® washer teeth. Do not use a module with a frame that prevents the WEEB® washer teeth from embedding fully.

SYSTEM OVERVIEW USING WEEB-FBM516

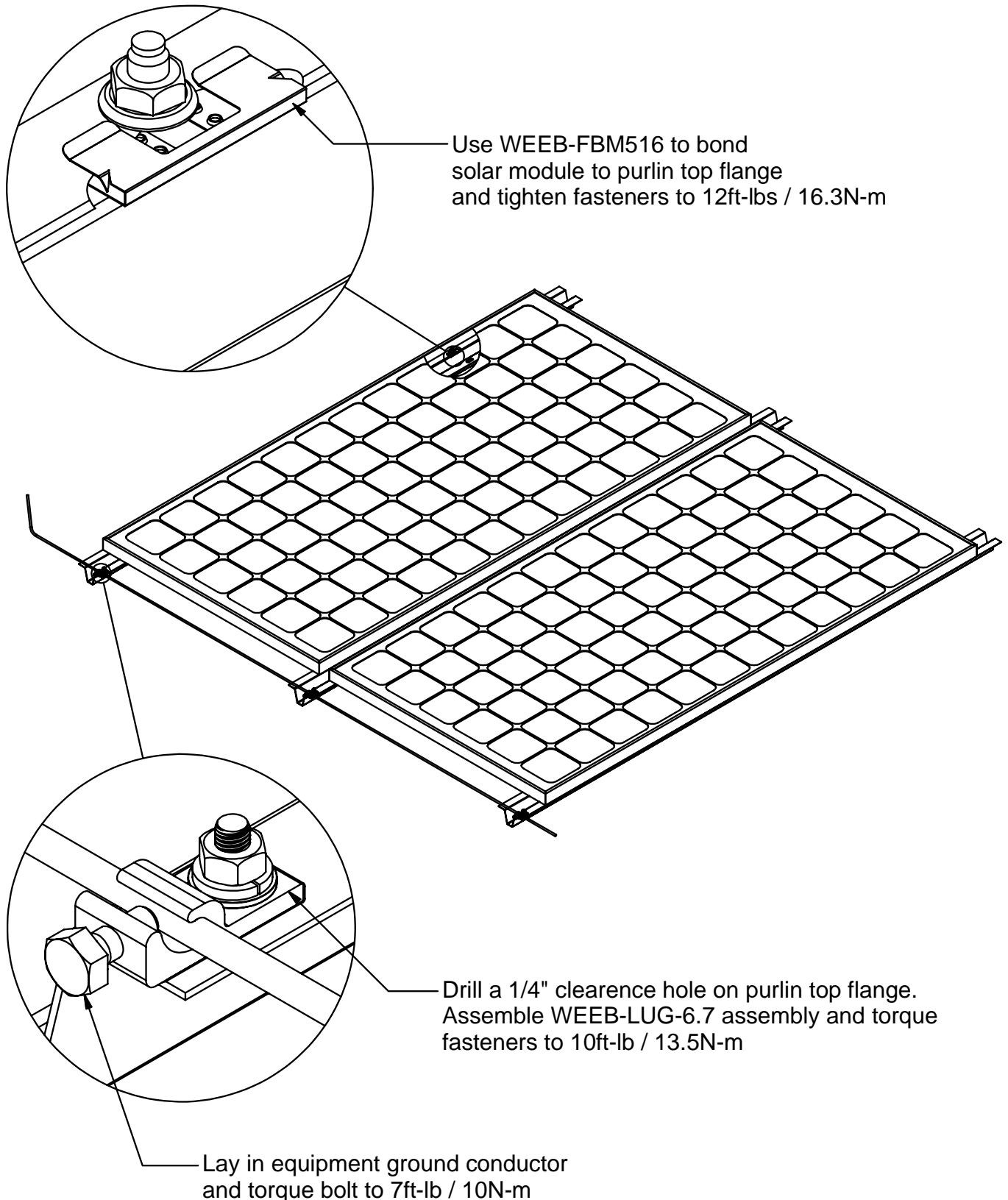

Important notes:

1. The NEC section 690.43 states "Exposed non-current carrying metal parts of module frames, equipment, and conductor enclosures shall be grounded in accordance with 250.134 or 250.136(A) regardless of voltage".

WEEB-FBM516 LAYOUT

EVEN NUMBER OF MODULES IN ROW

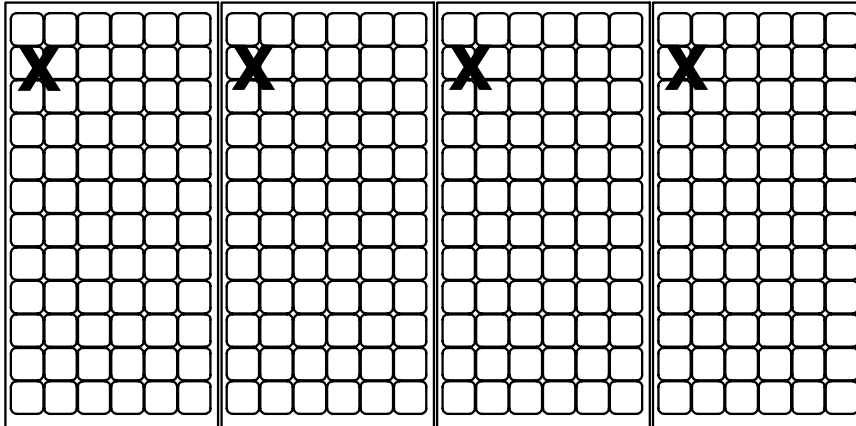

X DENOTES PLACES TO INSTALL WEEB-FBM516

$$C \times R = 4 \times 1$$

$$\text{WEEB-FBM516 NEEDED} = C \times R = 4 \times 1 = 4$$

ODD NUMBER OF MODULES IN ROW

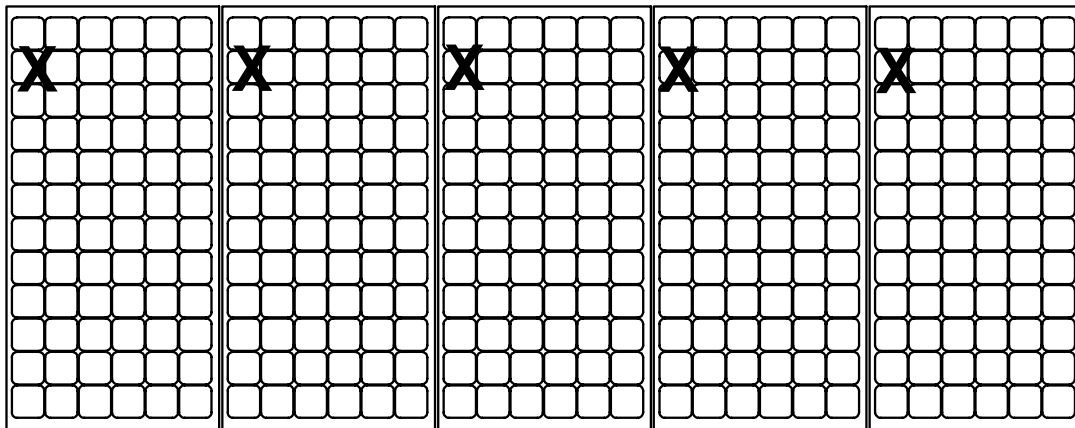

X DENOTES PLACES TO INSTALL WEEB-FBM516

$$C \times R = 5 \times 1$$

$$\text{WEEB-FBM516 NEEDED} = C \times R = 5 \times 1 = 5$$

Customer Service Department
7 Aviation Park Drive
Londonderry, NH 03053
1-800-346-4175
1-603-647-5299 (International)